

Pos. Nr. Pos. no.	Beschreibung Description	Art.-Nr. Art. no.	Preisgruppe Price bracket
1	Zugfeder Spring	86208	3
2	GF-Schraube M2x5 GF-Screw M2x5	114966	3
3	TS-Windleitbleche, Kesselbod. Part set boiler bottom	126577	12
4	TS-Tendertür, Stütze, FH-Rückwand Part set drivers cab rear panel, tender door	126580	12
5	TS-Kupplungsdeichseln+Stützen Part set	126583	13
6	TS-Fenster,Lichtleiter,Linse Part set window lens light transmission bar	126584	13
7	TS-Generator, Leitungen Part set lines, generator	126585	6
8	TS-Sandrohre, Ventile m.Handr. schwarz Part set sand lines, valve, handwheel black	126586	7
9	TS - Lampen, Pumpen, Steck. Part set lamps pumps...	126593	10
10	TS-Drahtstangen chem.geschw. Part set rods	126629	10
11	TS-für Kessel + Tender Part set for boiler + tender	126596	10
12	Umlauf lackiert Running board coated	129036	13
13	TS-Lok + Tendergewichte Part set loco + tender weight	126606	12
14	Kessel kpl. Betr.nr. <b>44 0233-5</b> Boiler ass. loco no <b>44 0233-5</b>	129035	34
15	Führerhaus kpl. Betr.nr. <b>44 0233-5</b> Drivers cab ass. loco no <b>44 0233-5</b>	129037	17

Änderungen in Konstruktion und Ausführung vorbehalten  
We reserve the right to change the construction and specification

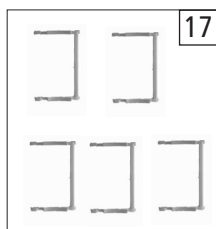

Pos. Nr. Pos. no.	Beschreibung Description	Art.-Nr. Art. no.	Preisgruppe Price bracket
1	Puffer flach Buffer, flat	107658	5
2	Puffer gewölbt Buffer, vaulted	107659	5
3	SK-Schraube M1,6x5 SK-Screw M1,6x5	115317	4
4	SK-Schraube M1,6x16/6 SK-Screw M1,6x16/6	123585	3
5	Zylinderblock Cylinder block	129029	10
6	TS-Vorlaufgestell, Lokboden, Steuerahmen Part set, pilot frame, loco bottom, steering fr.	126581	13
7	Kreuzkopfführung links+rechts Krosshead guide left+right	126582	9
8	Kuppelradsatz kleines Gewicht o. Haftr. Wheelset small weight without traction ties	126587	11
9	Kuppelradsatz kleines Gewicht m. Haftr. Wheelset small weight with traction ties	126588	12
10	Treibradsatz grosses Gewicht Wheelset big weight	126589	11
11	Kuppelradsatz mittleres Gewicht Wheelset middle weight	126590	11
12	Radsatz mit mittleren versetztem Gewicht Wheelset With middle slanted weight	126591	12
13	Vorlaufradsatz Pilot wheelset	126592	9
14	TS-Kuppelstangen Part set coupling rods	126597	15
15	TS-Steuerung Parts set steering	126598	10
16	TS-Luftkessel, Stützenteile Part set for boiler chassis frame	126599	6
17	TS-Bremsbacke Part set brake shoe hold down	126600	7
18	Lokgrundrahmen Loco frame	129030	16
19	Lokplatine kpl. Printed circuit assembly for loco	126607	27
20	TS-Federn für Lok u. Tender Part set springs for loco a. tender	126616	9
21	Haftringsatz 10Stk. Set w. traction ties 10pieces	129040	10
22	SK-Schraube M1,6x3 SK-Screw M1,6x3	125023	3
23	TS-Steuerungsträger Part set	126831	9

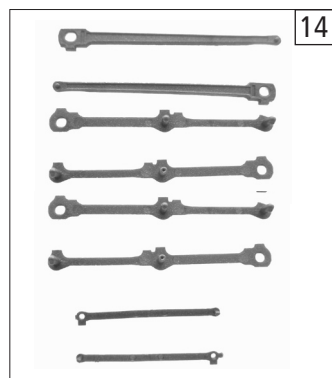
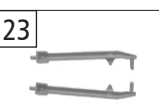
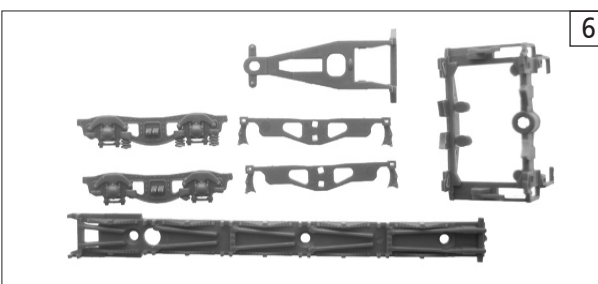
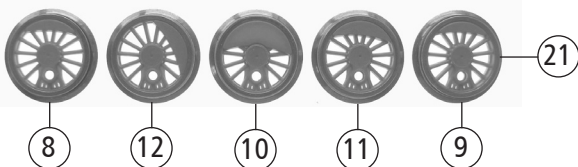
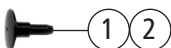
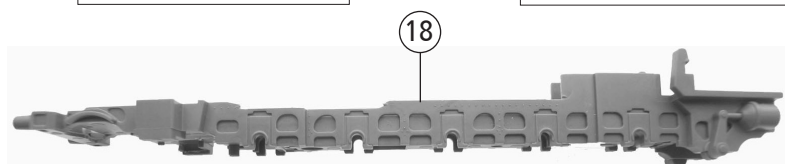
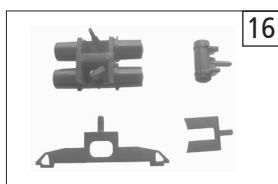
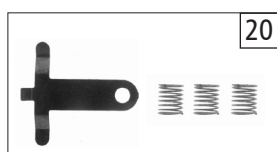
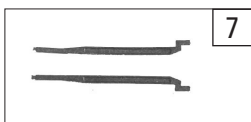
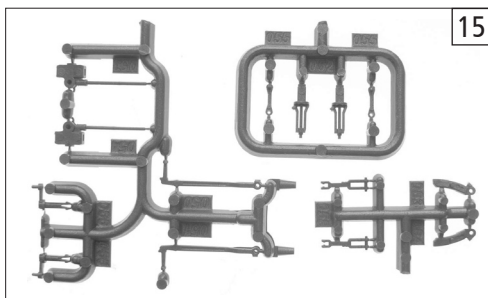
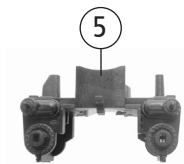
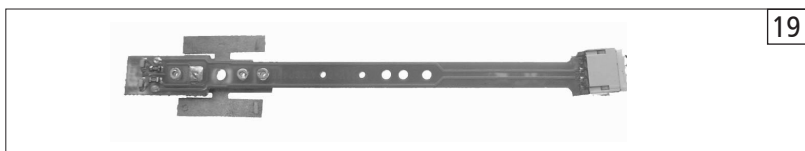
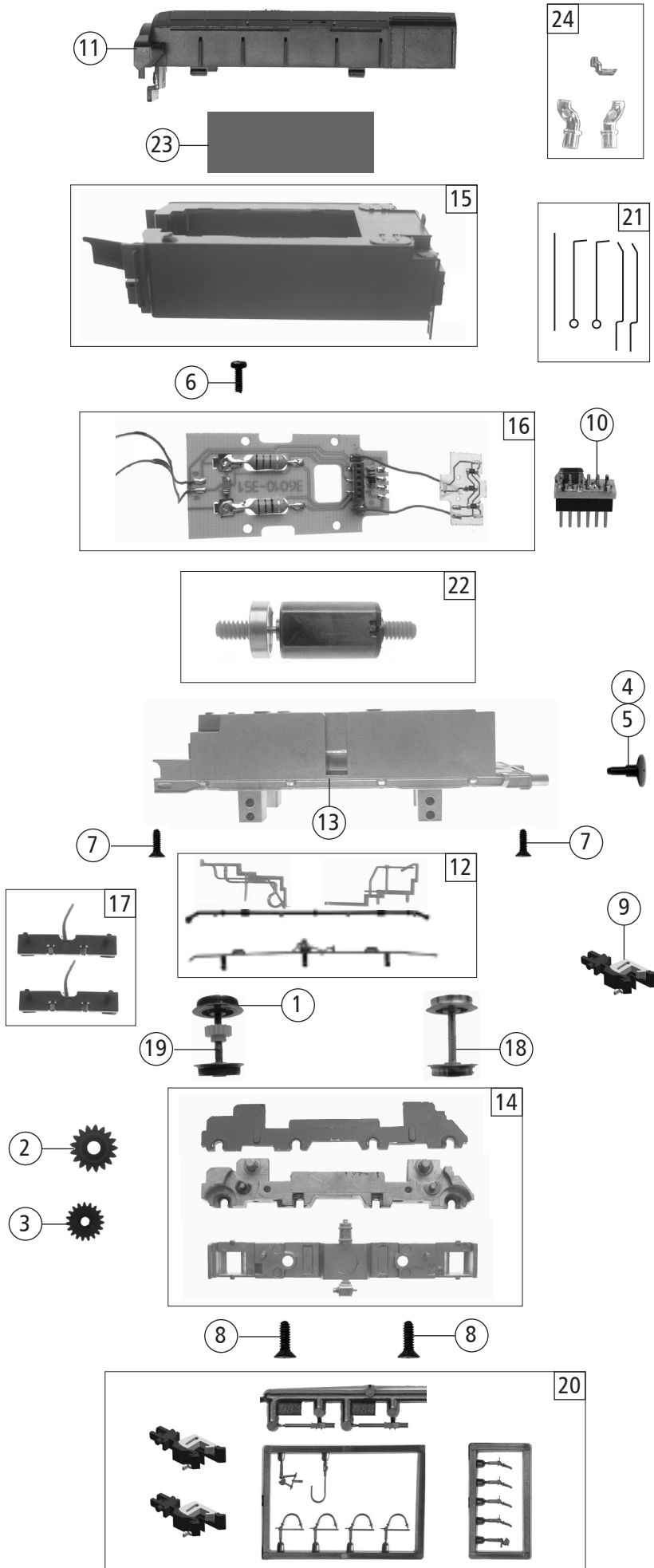

36018		DR	BR 44	=	
Pos. Nr. Pos.no.	Beschreibung Description	Art.-Nr. Art.no.	Preisgruppe Price bracket		
1	Hafringsatz 10Stk. 7,8mm Set with traction ties 10pieces 7,8mm	85617	10		
2	Schneckenzahnrad Z=22/12 Worm gear Z=22/12	86482	7		
3	Zahnrad Z=19 Gear Z=19	86499	3		
4	Puffer flach Buffer, flat	107658	5		
5	Puffer gewölbt Buffer, vaulted	107659	5		
6	GF-Schraube M1,6x4 mm GF-Screw M1,6x4 mm	114850	3		
7	SK-Schraube M1,6x5 mm SK-Screw M1,6x5 mm	115317	4		
8	Schraube M2x8 mm Screw M2x8 mm	120189	3		
9	TT-Kupplung TT-Coupling	131014	8		
10	Brückenbaugruppe Connector	126404	9		
11	Tender Ölaufsatz Oil attachment	129033	9		
12	TS-Tender-Führerhausleitungen Part set for tender and lines for drivers cab	126595	6		
13	Tendergrundrahmen Tender frame	129034	12		
14	Getriebebesatz Tender gear assembly	126603	11		
15	Tendergehäuse kpl. Betr.nr. 44 0233-5 (36012) Tender body ass loco no 44 0233-5	129031	27		
16	Tenderplatine kpl. Printed circuit assembly for tender	126620	25		
17	Tenderkontakthalter kpl. Tender contact holder ass.	126621	8		
18	Radsatz o. Haftring o. Zahnrad Wheelset without gear without traction ties	126623	10		
19	Radsatz m. Haftring m. Zahnrad Wheelset with gear with traction ties	126624	12		
20	Zurüstbeutel Bag with accessories	126630	10		
21	TS - Tendergriffstangen+Federn Part set handle bar	126631	10		
22	Motor Motor	126622	28		
23	Schaumstoff für Schalldämmung Foam for acoustic insulation	126838	4		
24	TS-Lichtleiter Part set light transmission bar	129032	13		

Ersatzteile erhalten Sie bei Ihrem Fachhändler, oder Ihrer Landesvertretung:  
You can order your Replacement Parts at your local dealer, your country representative: