

36010		DR	BR 44	=	
Pos. Nr. Pos.no.	Beschreibung Description	Art.-Nr. Art.no.	Preisgruppe Price bracket		
1	Zugfeder Spring	86208	2		
2	GF-Schraube M2x5 GF-Screw M2x5	114966	2		
3	TS-Windleitbleche, Kesselbod. Part set boiler bottom	126577	20		
4	TS-Tendertür, Stütze, FH-Rückwand Part set drivers cab rear panel, tender door	126580	20		
5	TS-Kupplungsdeichseln+Stützen Part set	126583	25		
6	TS-Fenster,Lichtleiter,Linse Part set window lens light transmission bar	126584	25		
7	TS-Generator, Leitungen Part set lines, generator	126585	7		
8	TS-Sandrohre, Ventile m.Handr. schwarz Part set sand lines, valve, handwheel black	126586	8		
9	TS - Lampen, Pumpen, Steckt. Part set lamps pumps...	126593	17		
10	Loknummer kurz Betr.nr. 44 1040 Loco number short loco no 44 1040	126594	17		
11	TS-für Kessel + Tender Part set for boiler + tender	126596	15		
12	Umlauf lackiert Running board coated	126604	25		
13	TS-Lok + Tendergewichte Part set loco + tender weight	126606	20		
14	Kessel kpl. Betr.nr. 44 1040 Boiler ass. loco no 44 1040	126625	70		
15	Führerhaus kpl. Betr.nr. 44 1040 Drivers cab ass. loco no 44 1040	126628	33		
16	TS-Drahtstangen chem.geschw. Part set rods	126629	15		

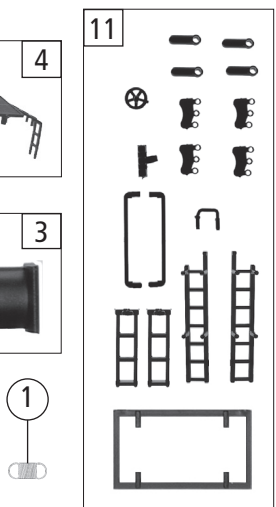

Änderungen in Konstruktion und Ausführung vorbehalten
We reserve the right to change the construction and specification

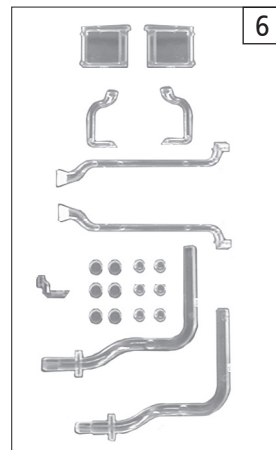
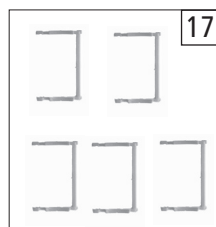
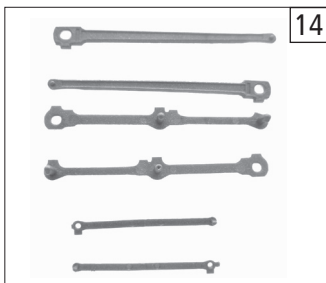
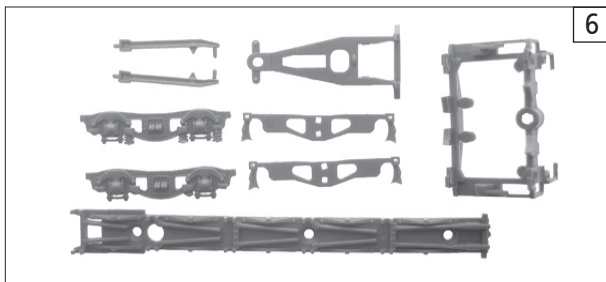
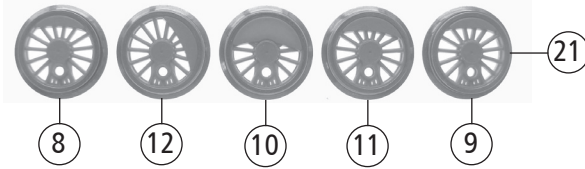
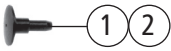
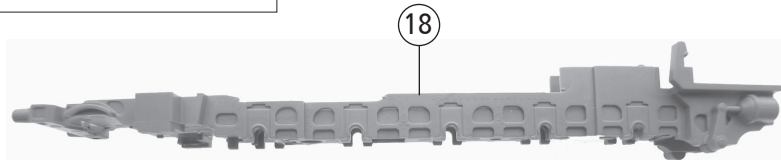
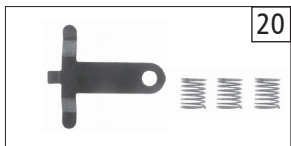
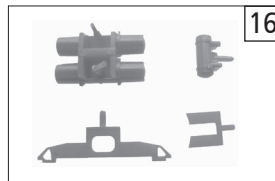
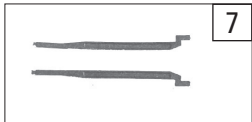
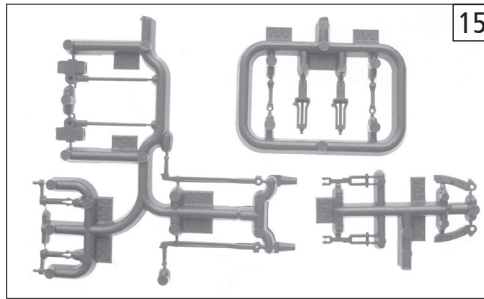
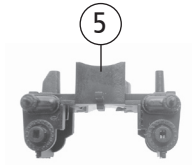
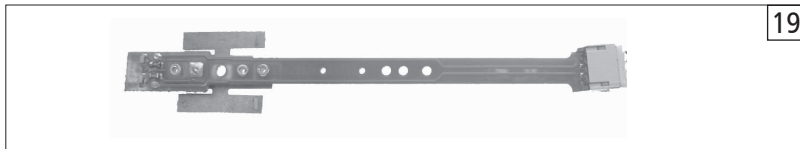

Pos. Nr. Pos.no.	Beschreibung Description	Art.-Nr. Art.no.	Preisgruppe Price bracket
1	Puffer flach Buffer, flat	107658	4
2	Puffer gewölbt Buffer, vaulted	107659	4
3	SK-Schraube M1,6x5 SK-Screw M1,6x5	115317	3
4	SK-Schraube M1,6x16/6 SK-Screw M1,6x16/6	123585	2
5	Zylinderblock Cylinder block	126578	15
6	TS-Vorlaufgestell, Lokboden, Steuerrahmen Part set, pilot frame, loco bottom, steering fr.	126581	25
7	Kreuzkopfführung links+rechts Krosshead guide left+right	126582	12
8	Kuppelradsatz kleines Gewicht o. Haftr. Wheelset small weight without traction tiers	126587	18
9	Kuppelradsatz kleines Gewicht m. Haftr. Wheelset small weight with traction tiers	126588	20
10	Treibradsatz grosses Gewicht Wheelset big weight	126589	18
11	Kuppelradsatz mittleres Gewicht Wheelset middle weight	126590	18
12	Radsatz mit mittleren versetztem Gewicht Wheelset With middle slanted weight	126591	18
13	Vorlaufradsatz Pilot wheelset	126592	14
14	TS-Kuppelstangen Part set coupling rods	126597	28
15	TS-Steuerung Parts set steering	126598	15
16	TS-Luftkessel, Stützenteile Part set for boiler chassis frame	126599	7
17	TS-Bremsbacke Part set brake shoe hold down	126600	9
18	Lokgrundrahmen Loco frame	126605	30
19	Lokplatine kpl. Printed circuit assembly for loco	126607	55
20	TS-Federn für Vorlaufgest. und Tendergetriebe Part set springs f. forward frame+tender gear	126616	14
21	Haftringsatz 10Stk. 8,5-12mm Set w. traction tiers 10pieces 8,5-12mm	85610	17

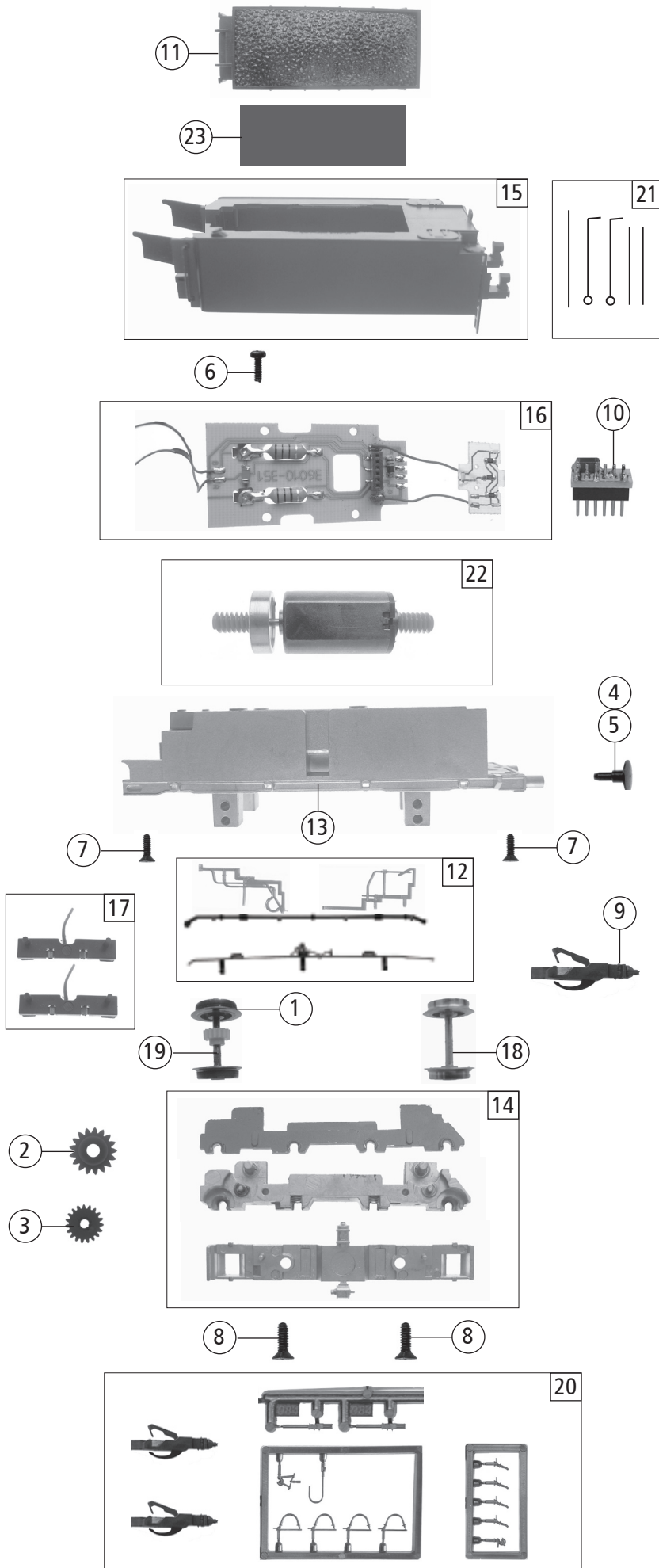

Pos. Nr. Pos.no.	Beschreibung Description	Art.-Nr. Art.no.	Preisgruppe Price bracket
1	Haftringsatz 10Stk. 7,8mm Set with traction tiers 10pieces 7,8mm	85617	---
2	Schneckenzahnrad Z=22/12 Worm gear Z=22/12	86482	3
3	Zahnrad Z=19 Gear Z=19	86499	2
4	Puffer flach Buffer, flat	107658	4
5	Puffer gewölbt Buffer, vaulted	107659	4
6	GF-Schraube M1,6x4 mm GF-Screw M1,6x4 mm	114850	2
7	SK-Schraube M1,6x4 mm SK-Screw M1,6x4 mm	115161	2
8	SK-Schraube M2x8 mm SK-Screw M2x8 mm	120189	2
9	TT-Kupplung TT-Coupling	124371	19
10	Brückenbaugruppe Connector	126404	12
11	Tender Kohlenaufsatz Coal attachment	126579	12
12	TS-Tender-Führerhausleitungen Part set for tender and lines for drivers cab	126595	7
13	Tendergrundrahmen Tender frame	126601	20
14	Getriebesatz Tender gear assembly	126603	19
15	Tendergehäuse kpl. Betr.nr. 44 1040 Tender body ass loco no 44 1040	126619	25
16	Tenderplatine kpl. Printed circuit assembly for tender	126620	50
17	Tenderkontakthalter kpl. Tender contact holder ass.	126621	10
18	Radsatz o. Haftring o. Zahnrad Wheelset without gear without traction tiers	126623	16
19	Radsatz m. Haftring m. Zahnrad Wheelset with gear with traction tiers	126624	20
20	Zurüstbeutel Bag with accessories	126630	15
21	TS - Tendergriffstangen+Federn Part set handle bar	126631	16
22	Motor Motor	126622	57
23	Schaumstoff für Schalldämmung Foam for acoustic insulation	126838	3

Ersatzteile erhalten Sie bei Ihrem Fachhändler, oder Ihrer Landesvertretung:
You can order your Replacement Parts at your local dealer, your country representative: